

LARIO

Pavimento

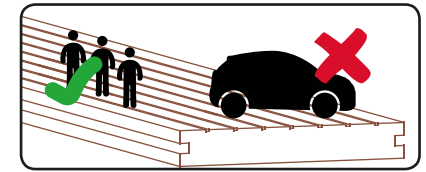

1 Controllo misure e spazi

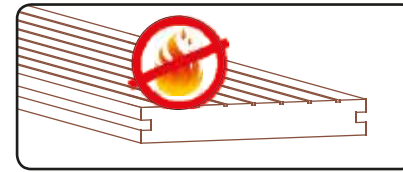
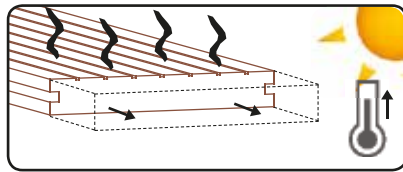
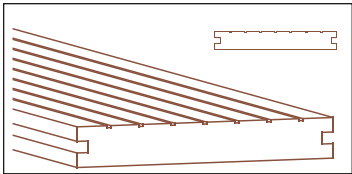

(A)

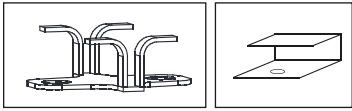

(B)

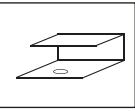

(C)

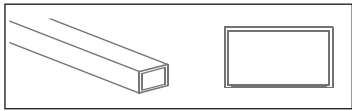

(D)

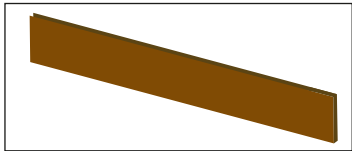

(E)



3 mm



10.12/
2.5mm

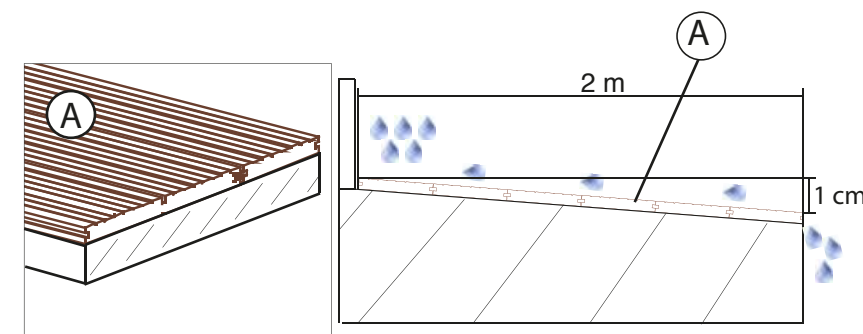
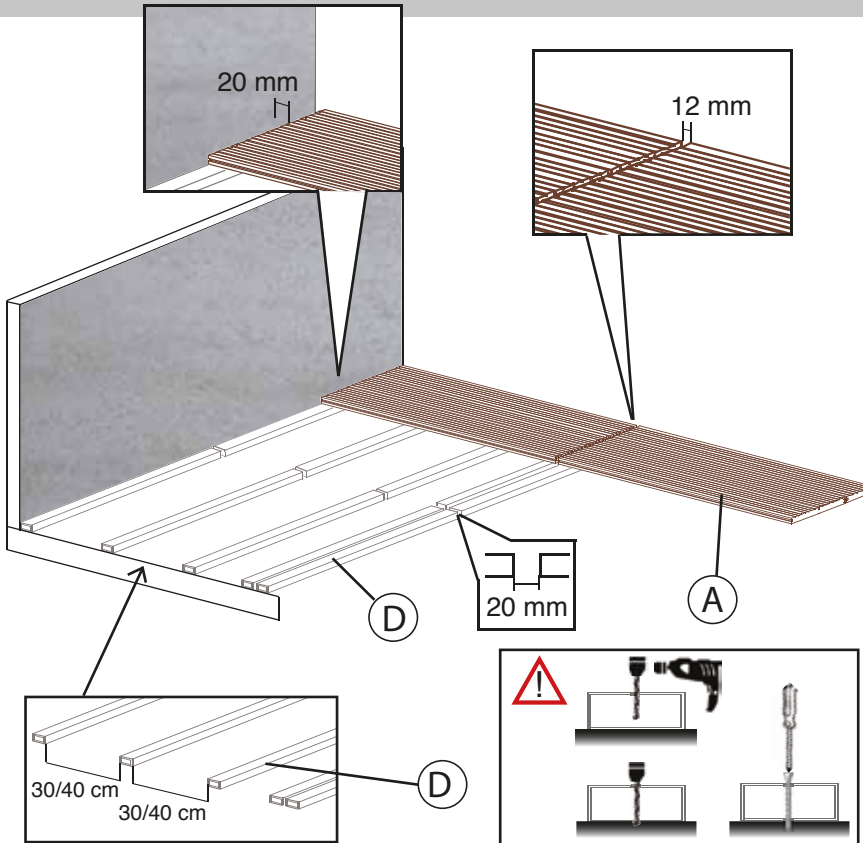

2 Posa del pavimento

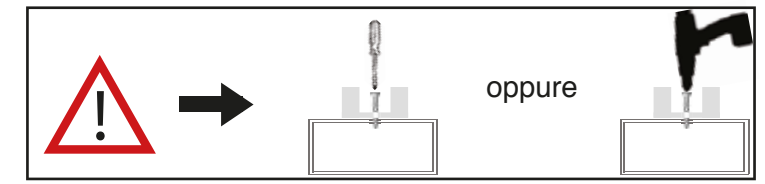
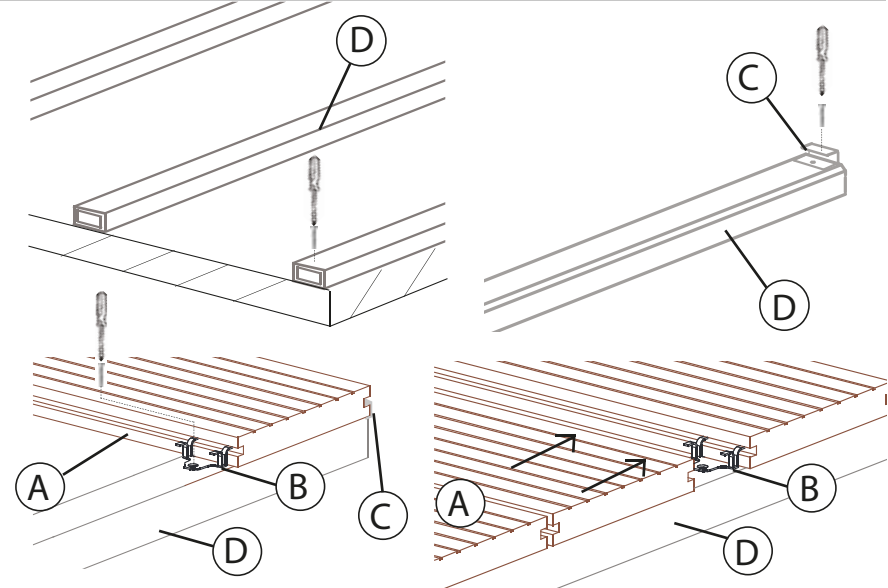

3 Eventuale rifinitura

